

Engineers Guide To Clamps and Workholding

E-HANDBOOK

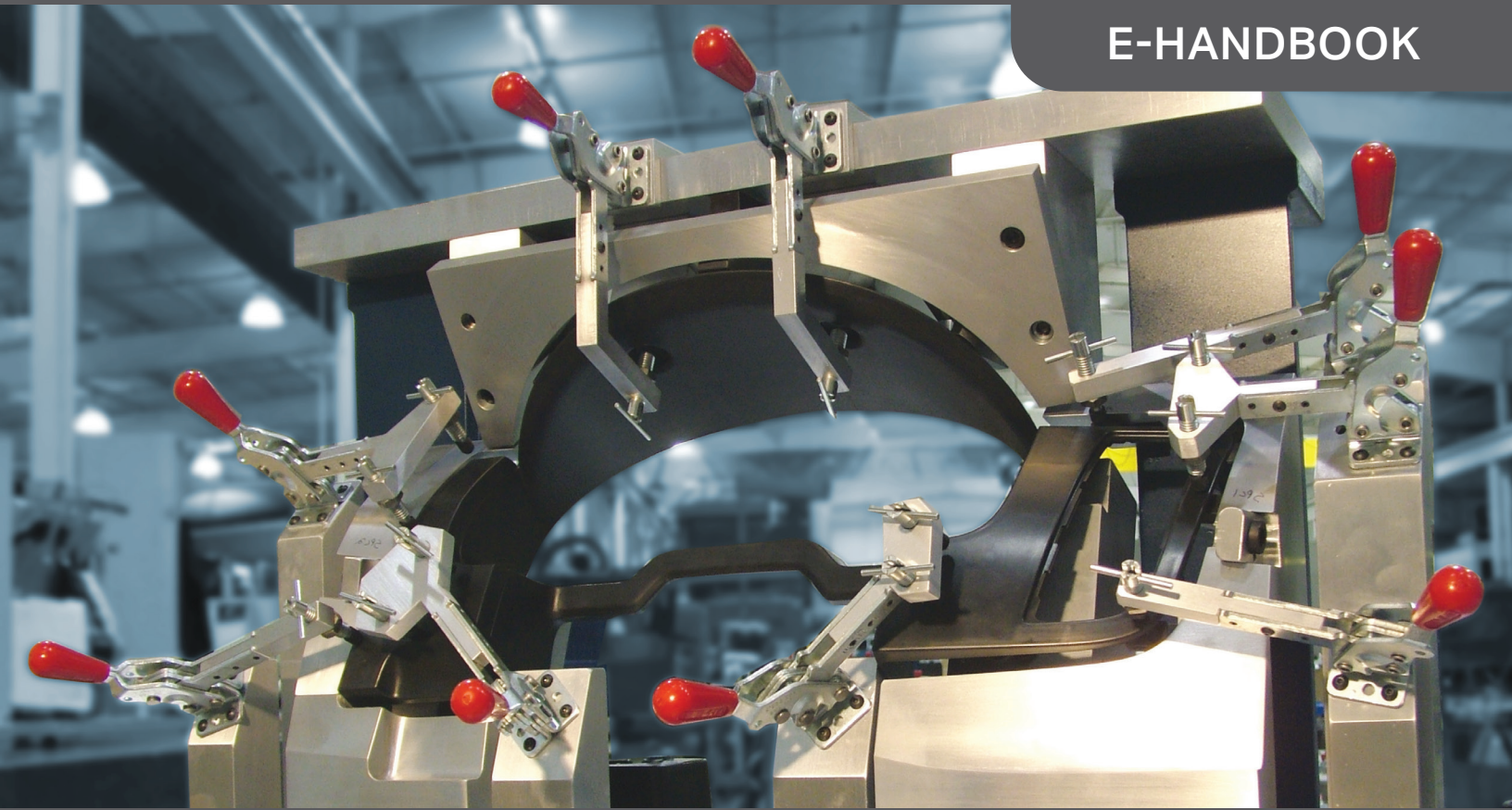

Reid SUPPLY
AN ESSENTRA COMPANY

☎ 1.800.253.0421
✉ sales@reidsupply.com
🌐 reidsupply.com

CLAMPS & WORKHOLDING

Contents

Terminology	1	Space Allotted	13
Clamping and Workholding Basics.....	1	Material	13
Physics Revisited.....	1	Clamp Position	14
Torque	2	Figure 6: Sample Clamp Positions	14
Vectors.....	2	Remote Operation.....	15
Figure 1: Force Vector Analysis.....	2	Cycle Time	15
The Art of Fixturing and Design.....	3	Maintenance	15
Jig vs. Fixture	4	Human Factors	15
Locating.....	4	Angle of Approach	16
Degrees of Freedom	4	Applied Forces	16
Table 1: Cartesian Coordinate System ¹ Degrees of Freedom.....	4	Grip	16
Machining Forces	5	Feedback	16
Eq1: Convert SFM to RPM	6	Figure 7: Example Power Clamp with Feedback.....	17
Eq2: Determine material removal rate (MRR).....	6	Safety.....	17
Eq3: Calculate Spindle Horsepower	6	Selecting the Correct Component.....	18
Eq4: Calculate force transmitted from the tool to the workpiece.....	6	Selection Parameters	18
Eq5: Calculate the Required Clamping Force.....	6	Workpiece	18
Clamp vs. Fastener	7	Required Holding Force (F_H).....	18
Table 2: Clamp vs. Fastener for Workpiece Hold-Down Applications	7	Workholding Type	19
Workholding Forces	7	Table 3: Types of Workholding Devices	19
Maximum Holding Capacity (F_{HC}).....	7	Cost.....	20
Clamping Force (F_C) Exerting Force (F_E) Holding Force (F_H)	8	Clamp Specifications.....	20
Clamps	8	Clamping Force for Strap Clamp	20
Single-Ended Clamp.....	8	Figure 8: Sample Strap Clamp Application	20
Figure 2: Clamping Force (F_C) vs. Exerting Force (F_E).....	8	Table 4: Threaded Stud Clamping Forces	21
Figure 3: Workholding Example - Single ended Clamp	8	Maximum Holding Capacity.....	21
Figure 4: Sample Holding Force Calculation for Hold-Down Type Toggle Clamp	10	Size	21
The Toggle Clamp	10	Modifications.....	21
Figure 5: Toggle Clamp Operation	10	Power Workholding Devices	21
Design Considerations	11	Table 5: Single-Action vs. Double-Action Pneumatic and Hydraulic Cylinders	22
Workholding Applications	11	Workholding Devices	23
Assembly	12	Table 6: Workholding Devices	24
Machining.....	12	Table 7: Workholding Attributes	25
Test	12	Workholding Attributes.....	25
Physical Attributes	13	Toggle Clamps	26
Applied Forces	13	Table 8: Toggle Clamp Pros & Cons	27
		Table 9: Toggle Clamp Styles	27
		Table 10: Toggle Clamp Attributes	28

CLAMPS & WORKHOLDING

Contents Cont.

Toggle Clamp Attributes	28
Power Workholding	31
Table 11: Power Workholding Pros and Cons	32
Pneumatic Clamps	32
Table 12: Power Workholding Devices	32
Pneumatic and Hydraulic Clamps	33
Table 13: Power Workholding Devices	33
Pneumatic/Hydraulic Clamp Attributes	33
Table 14: Power Workholding Attributes	34
Custom Products	35
Summary	35
Glossary	36
References	38
Notes	38



**Check Out Clamps &
Workholding Catalog**

CLAMPS & WORKHOLDING

The purpose of this Resource Guide is to aid customers in the selection of heavy-duty industrial products in the Clamps and Workholding category of Reid Supply product offerings for your desired application, new or existing.

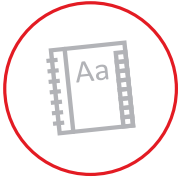

Terminology

Terms defining products are typically determined by the vendor. Much of this may not be standard. A glossary of terms used in this document has been included at the end of the manual.

As Reid Supply purchases its products from several vendors, it is sometimes difficult to sort and categorize these differences. If you find yourself confused by terminology in the catalog or this document, try shopping online using the website listed below or contact us at sales@reidsupply.com.

Clamping and Workholding Basics

Heavy-duty workholding systems are crucial in industrial production. They ensure repeatability, accuracy and rapid changeover and setup.

Many basic laws of physics apply during clamping and workholding; especially Newton's Third Law of Motion, which states, "For every action there is an equal and opposite reaction". For industrial clamping and workholding, the application designer must understand the forces involved, especially for machining where the cutting tool supplies significant external forces. Even during assembly, two or more pieces must be held together long enough for joining or fastening. In some cases, although the clamp or workholding device may be strong enough to control the workpiece, the fixture, jig or mounting base may not be strong enough to counter such forces.

To correctly purchase and apply workholding devices for heavy-duty industrial applications requires a good understanding of the forces within the workholding system. This does not imply you need an engineering background or be a wiz at math to design and build an effective workholding system; especially for an assembly application. However, it is best to have a basic understanding of the forces involved.

In machining applications, forces can be very high and occur in multiple directions. In any workholding system, the necessity to understand and deal with such forces become greater as forces (and risk factors and safety issues) increase.

Note: Many of the terms in this discussion can be found in the Glossary at the end of this document.

Physics Revisited

Before looking more closely at industrial workholding, let's revisit some terms associated with force analysis.

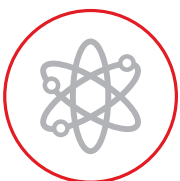

CLAMPS & WORKHOLDING

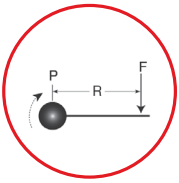

Torque

Torque (**T**) is a measure of force (**F**) over distance (**R**). The unit of measure for torque is Newton-Meters (Nm) for metric, or Foot-Pounds (ft-lbs) and Inch-Pounds (in-lbs) in the imperial system. An example of applying torque is when a person weighing 150 lbs attempts to loosen a nut with a 10-inch wrench and it won't budge. The fix: add a pipe and get 20 inches more torque. The resulting torque at the pivot point (P) would be **$T = RF$** :

With 10-inch wrench only: $T = 10 \text{ in} \times 150 \text{ lbs} = 1500 \text{ in-lbs}$

With 20-inch extension: $T = 30 \text{ in} \times 150 \text{ lbs} = 4500 \text{ in-lbs}$

Torque is almost always a factor in clamping and workholding because the applied force is typically at the end of an extended arm or mounting bracket. Even with a "C" clamp, torque is applied to a common internal stress point located near the center of the clamp body attempting to pull the clamp apart.

Vectors

Any time a force is applied, vectors pertain in analyzing the stresses involved. A vector is any quantity having both magnitude and direction. A vehicle can travel at 20 mph, but not without a direction (or when applying a force at an angle to a surface). Graphically, a vector is represented (Figure 1) by a line having a length (magnitude) and a single arrowhead (direction). In most cases, it is drawn in the Cartesian coordinate system, as shown on the left.

FIGURE 1: FORCE VECTOR ANALYSIS

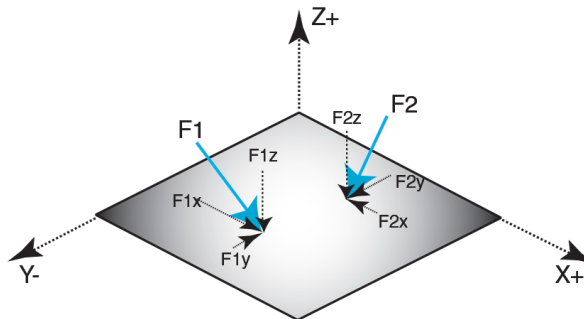

For the analysis (Figure 1) of two or more vector forces (such as when a cutting tool impacts a workpiece held on a table), we may need to add the resulting forces to determine the necessary hold-down pressure and in what direction. In some cases the clamp spindle, or clamping point, cannot be ideally normal to the part surface. In this case, the resulting hold-down force has components that both press the workpiece into the fixture or table, but also push it along the surface (side-loading), as also indicated in Figure 1.



Without going through the trigonometry and math, let's assume the magnitude of $F_1 = F_2$ in Figure 1. In the figure, we see two forces apply at different angles and different directions. If we only look at the resulting forces (x, y and z) along the axes, we see that $\Sigma F_z = F_1z + F_2z$, the resultant holding force is accumulative in the Z- direction and less than $\Sigma F = F_1 + F_2$. Plus, if we look at the resultant forces for $\Sigma F_x = F_1x + F_2x$ and $\Sigma F_y = F_1y + F_2y$, the resulting side-loading forces are in the X+ and Y- directions respectively. This can be significant for two reasons:

1. Where we may have expected two 100-lb holding forces applying 200 lbs to our workpiece, the resultant force may be only 140 lbs;
2. The resulting sideloading can cause our workpiece to shift during machining, assembly or testing as these forces are applied. A workpiece is stable when $\Sigma F_x = \Sigma F_y = \Sigma F_z = 0$; before and during machining, assembly or testing.

The Art of Fixturing and Design

A good industrial designer is like an artist, as imagination is a large part of design. Fueling such imagination is the education and knowledge of what tools and hardware are available and how to apply them. Ongoing technological updates and discoveries lead to new and improved fixture and tool design options. Keeping up with these changes and updates is necessary to be competitive in today's technologically advancing world.

Although automation has reduced the number of tool and die makers, the fixturing and design art is still very much alive. Designers continue to develop and use heavy-duty Clamps and Workholding components for systems ranging

from manually mounting the workpiece for a CNC operation to fully automated pick-and-place systems with robotics and end-effectors. As long as there is a need for manufacturing and machining of materials, tools and parts will continue to exist, and designers will be need to apply their art form to design and build workholding systems.

The designer first examines the workpiece(s) for properties that will affect workholding design:

- Material - hardness, thickness, strength, etc...
- Surface - rough or smooth.
- Shape - flat, curved, round or a combination of each.
- Datums or critical dimensions
- Orientation during processing

With this knowledge, the designer must determine the best locating and workholding system that will:

- not harm or damage the workpiece, workholding system, machine, tool or human.
- control the workpiece(s) during machining, assembly or testing.
- perform effectively and efficiently to obtain the best cycle time.



CLAMPS & WORKHOLDING

Jig vs. Fixture

It's easy to confuse a jig and a fixture. Seemingly they do the same thing, however, there is a clear distinction; a jig guides a tool or other device along a path or in a specific direction, while a fixture locates and holds the workpiece during machining, assembly or testing. A jig is usually custom-made. An industrial application can include both a jig and a fixture in one unit. An example of a jig is when duplicating a key; the original functions as a jig so the new key follows the same path as the old one. Jigs can also feature in assembly to guide a fastener or part into position while the fixture holds two or more pieces together.

In the advent of automation and CNC machines with motion control, jigs are not required because tool location and path are digitally programmed and stored in memory. Fixtures continue to be a vital part of manufacturing for both manual and automated applications; so much so that much of this manual and the Clamps and Workholding category in the Reid Supply catalog is devoted to it.

Locating

Locating the workpiece correctly must take place before clamping. This is done by positioning the workpiece and restricting the degrees of freedom at that location. The workpiece is properly located when:

- the workholding system allows for zero degrees of freedom or motion is restricted in all directions for a given location during machining, assembly or testing.
- only one orientation of the workpiece allows for correct placement in the fixture.

Degrees of Freedom

There are 12 degrees of freedom for workholding in the standard Cartesian coordinate system; six linear and six radial.

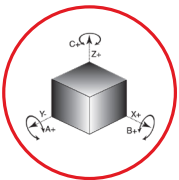

TABLE 1: CARTESIAN COORDINATE SYSTEM' DEGREES OF FREEDOM

12 Degrees of Freedom	Examples	Allowed Motion In	Comments
	<p>A</p>	X+, X- Y+, Y- Z+ C+, C-	Five of twelve degrees of freedom are eliminated with the workpiece sitting on a single flat surface.
	<p>B</p>	X+, X- Y- Z+	With the addition of a wall along a second axis, three more are eliminated.
	<p>C</p>	X- Y- Z+	Another degree of freedom is removed by restricting on three sides of the workpiece.

1) The Cartesian coordinate system follows standard axes guidelines for mathematics, physics, machining and the Right-Hand Rule.

In Table 1, above, we see six linear (X+, X-, Y+, Y-, Z+, Z-) and six radial (A+, A-, B+, B-, C+, C-) degrees of freedom and the potential for our workpiece to move in 12 directions. In example A, we see motion restricted in five of the 12 degrees of freedom. Example B shows another three, eight total, directions of motion restricted. Example C leaves only three degrees of freedom for the workpiece. Note that only one post could have been used, but in an automated locating system, two would work better because the workpiece is more secure for machining, assembly or testing. Also note that the use of one post, the one on the right, could simply move the pivot point in C+ from the corner at the wall to the clamping point of the post. External forces could still move the workpiece location.

Depending on the external forces applied, in some applications it may be redundant to restrict all degrees of freedom. For instance, in a finishing operation, forces applied by the tool may be downward and in the X+ directions. Unless you expect some form of kickback, it may not be necessary to restrict motion in the X- direction.

Machining Forces

Unlike assembly and testing workholding, machining adds external forces to the workholding system. There are many articles, books and courses for calculating the forces involved in a workholding system. We will only look at some basics in this discussion.

Determining machining forces must take place to build a workholding system strong enough to secure the workpiece without movement or distortion. Cutting tool speed and feed information needed to machine various materials can assist in calculating external machining forces to the workholding system. These values can be found:

- using the machinist calculator {14}.
- in reference books.
- from the tool manufacturer.
- by contacting Reid Customer Service using the toll-free number at the bottom of the page.

Using tool data, external forces exerted by the tool and machining can be calculated using the following formulas:

NOTE : Even this is a ballpark assessment as there are many other factors involved: machine capabilities, materials, etc... that influence all forces in the workholding system. Tests must also be run to ensure the integrity of the design.



Check Out Clamps & Workholding Catalog

CLAMPS & WORKHOLDING

Eq1: Convert SFM to RPM

$$RPM = \frac{SFM \times 12}{\pi \times D}$$

- Where:** **RPM** = spindle speed in revolutions per minute
SFM = tool surface feet per minute
12 = value to convert feet to inches, 12 in /1 foot
 π = mathematical symbol for the ratio between the diameter and radius of a circle
D = tool diameter in inches

Eq2: Determine material removal rate (MRR)

$$MRR=(W)(D)(F)(N)(RPM)$$

- Where:** **MRR** = material removal rate in in³/minute
W = width of cut in inches
D = depth of cut in inches
F = feed per tooth in inches
N = number of cutter teeth
RPM = spindle speed

Eq3: Calculate Spindle Horsepower

$$P_{Spindle}=(K_p)(MRR)$$

- Where:** **$P_{Spindle}$** = Spindle horsepower (hp). Although the spindle may be capable of producing more horsepower, this value is what is produced for the material and tool used.
 K_p = Power constant obtained from reference tables {1, 2, 3, 5, 6}. Factors affecting the power constant include workpiece material microstructure and hardness, feed rate, rake angle of the cutting tool and sharpness of tool.

Eq4: Calculate force transmitted from the tool to the workpiece

$$F_{Tool} = \frac{26400P_{Spindle}}{SFM}$$

- Where:** **F_{Tool}** = cutting force transmitted to the workpiece, inch-pounds
26,400 = 33,000 ft-lb/min conversion factor, with 80% efficiency
 $P_{Spindle}$ = the spindle horsepower (hp) calculated in Eq3
SFM = tool surface feet per minute

Eq5: Calculate the Required Clamping Force

$$F_{Clamp} = \frac{1.5F_{Tool}}{\mu}$$

- Where:** **F_{Clamp}** = required Clamping Force (F_c) to resist cutting force, in pounds (lb)
 F_{Tool} = cutting force from Eq4, in pounds (lb), with a 1.5 safety margin for hydraulic clamping
 μ = coefficient of friction for material being machined

The results of Eq5 returns the amount, or magnitude, of the total Clamping Force required to secure the workpiece in the opposite direction of the cutting tool applied force. It does not take into consideration other devices that may contribute to the required F_c , such as locating cylinders and locators or stops.

CLAMPS & WORKHOLDING

Clamp vs. Fastener

As stated before, fixturing is an art. The creative use and application of clamps and fasteners to perform workpiece hold down is common practice. However, if either can be used, a toggle clamp has definite advantages as listed in Table 2.

TABLE 2: CLAMP VS. FASTENER FOR WORKPIECE HOLD-DOWN APPLICATIONS

Feature	Clamp	Fastener
Tools Required	None	Depending on fastener, possibly a wrench.
Speed	Open and close with a single stroke with less operator fatigue	Normally requires a tool and several turns to release.
Remote Operation	Yes, with pneumatics or hydraulics.	No, requires a tool to manually remove and replace.
Occasional Access	Depending on selection, may deflect from fatigue under long periods of stress.	Can hold continuous clamping for long periods of time.
Components Handled	Although the clamp may consist of multiple components, they are self contained and the operator only has to operate one unit.	Depending on the fastener, usually a bolt and nut are involved, possibly a washer. In some cases, the fastener is disassembled and reassembled during application. Components could get misplaced or lost.

In most cases where the fastener needs removing and replacing for production purposes, productivity is increased by substituting a clamping device(s). Even modular fixtures can be held in place with a clamp.

Workholding Forces

In any industrial workholding application, at least two opposing forces occur that work against each other to secure the workpiece. Workholding forces are applied directly against a fixture or a locator on the fixture. In either case, clamp location is important. If against a fixture or other mounting surface, the location may not be as critical due to the large surface area.

Offset loading can occur when the Holding Force (F_H) does not directly align with the Opposing Force (F_O) of the locator. This can result in deflection and/or distortion of the workpiece during machining, assembly or testing.

NOTE : More details about workholding forces is discussed later in this section of the manual.

Maximum Holding Capacity (F_{HC})

The primary specification for selecting any heavy-duty clamp is its Maximum Holding Capacity (F_{HC}). Holding Force (F_H) is the current amount of force applied to the workpiece at any time during machining or assembly. Although a clamp may be applying an initial Exerting Force (F_E in Figure 2) against the workpiece to hold position, F_H is usually much more. **If $F_H > F_{HC}$, clamp integrity may be compromised resulting in a failure of your workholding system to secure the workpiece.**

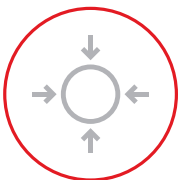

CLAMPS & WORKHOLDING

Clamping Force (F_C) Exerting Force (F_E) Holding Force (F_H)

While Clamping Force (F_C) is the desired amount of force a clamp exerts on the workpiece, the actual Exerting Force (F_E) is the vector component of F_C normal to the workpiece, Figure 2, at the clamping point (P_C). Ideally, $F_E = F_C$ and both are normal to the workpiece at P_C .

FIGURE 2: CLAMPING FORCE (F_C) VS. EXERTING FORCE (F_E)

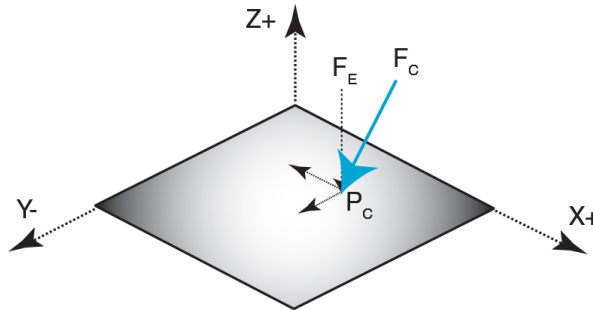

Holding Force (F_H) is the amount of force required to hold the workpiece in place during machining, assembly or testing. In normal applications, $F_C = F_E > F_H < F_{HC}$. In other words, **the Maximum Holding Capacity (F_{HC}), defined, must not be exceeded.** In terms of vectors, **F_H is the sum of all normal vector components of all Opposing Forces (F_O) against F_E .** This includes friction and machining, assembly or testing forces which can cause the workpiece to move in the fixture or workholding system. During machining, assembly or testing, until F_{HC} is reached, F_E will adjust as F_H changes due to the addition of external forces.

Clamps

Single-Ended Clamp

For a single-ended clamp, e.g. a hold-down toggle clamp (Figure 4) or strap clamp, the applied Exerting Force (F_E) is against a workpiece and opposed (F_O) by a common mounting base, a location point or fixture stop. Together they make up the equivalent of the double-ended clamp. Since the mounting base and all other fixturing is an unknown to this document and the makers of the single-ended clamp, only details relative to the clamp will be considered at this point.



FIGURE 3: WORKHOLDING EXAMPLE - SINGLE ENDED CLAMP

Eq6: if on the same axis,

$$F_S = F_E = F_O > F_H < F_{HC}$$

Eq7: $F_S R_S = F_{HC} R_{HC}$

Eq8: $F_S = F_{HC} R_{HC} / R_S$

Transposing Eq8:

Eq9: $F_{HC} = F_S R_S / R_{HC}$

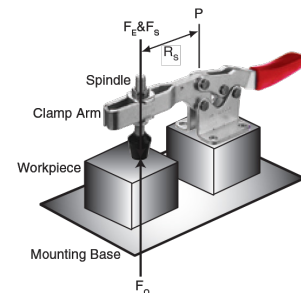

CLAMPS & WORKHOLDING

Where: F_E	= The amount of force being exerted by the spindle perpendicular to the workpiece surface at the clamping point
F_H	= The amount of Holding Force required to hold the workpiece securely in position. Ideally, at all times, F_E is greater than or equal to F_H .
F_{HC}	= Rated Maximum Holding Capacity tested at 0.5 inches from front edge of mounting base for Destaco toggle clamps.
F_O	= Opposing Force by workpiece at clamping point.
F_S	= Holding Force measured at the spindle or clamping point.
P	= Pivot point (P) of clamp bar.
R	= Radius or distance from pivot point (P).
R_{HC}	= Radius used during testing to establish FHC. For Destaco toggle clamps, this distance is from the clamp bar pivot point (P) to 0.5 inch beyond the edge of the mounting base.
R_s	= Distance from pivot point (P) to spindle location.

Figure 3 shows the analysis of a single-ended, hold-down toggle clamp. The clamp is exerting a downward force (F_S) on the workpiece at the contact point. If the spindle is mounted perpendicular to the workpiece surface at the contact point, F_E , F_S and F_O are equal (Eq6). During machining, assembly or testing, these forces are dynamic and the required Holding Force (F_H) will adjust with the external forces. The workpiece, jig and any other mounting support for the workpiece is resisting downward motion by exerting an equal and opposite force (F_O) against the clamp at the clamping point.

Testing for the rated Holding Capacity (F_{HC}) involves measuring the force (F_S) applied by the spindle over a fixed distance R_{HC} from the pivot point (P). In the case of Destaco hold-down toggle clamps, the test spindle is mounted 0.5 inch (closest point for the test equipment) out from the mounting base front edge. The equipment measures the maximum F_{HC} applied on the clamp bar before clamp deflection or damage. Specifications for these clamps include the dimensions for mounting base and clamp arm. Stroke, spindle data and the Holding Capacity (F_{HC}). R_{HC} must be determined from the CAD file or PDF catalog available online or from our printed catalog, all of which are available free.

Applying F_{HC} and R_{HC} to Eq7 or Eq8 of Figure 3, the application designer can now use this information to calculate Holding Force at any point (R_s) along the clamp bar; even if the clamp bar needs to be extended. If F_S is known, by transposing Eq8, the designer can now calculate F_{HC} (Eq9), which is required to purchase a hold-down clamp.

As seen in Figure 3, the Opposing Force (F_O) is opposite and equal to F_E . External forces, such as drilling or milling, should be applied opposite the clamp and work against F_O ; not toward the clamp. The surface of F_O should be in the form of a gripper, rest pad, locator or fixture surface as shown.

NOTE: Strap clamp analysis is similar to the toggle clamp, but the F_S is typically fixed and labeled FC as in the section on Workholding Forces. Because F_C is applied at a fixed contact point, no calculations are required. Refer to the section on Clamping Forces for Strap Clamps for more details.

CLAMPS & WORKHOLDING

FIGURE 4: SAMPLE HOLDING FORCE CALCULATION FOR HOLD-DOWN TYPE TOGGLE CLAMP

For our workholding application the desired clamping point of the spindle is 3.5 inches from the front edge of the clamp mounting base.

We have determined a minimum holding force (F_S) of 105 lbs is required at the spindle contact point.

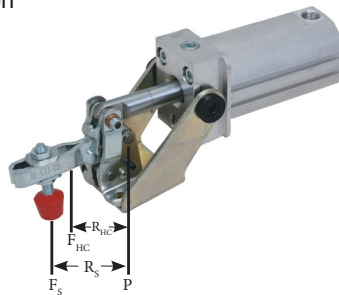

Available Toggle Clamp:

Destaco
Series TC-802-U
Pneumatic Hold-Down Action
Clamp

Holding Capacity: 200 lbs

From the catalog (print or online), we see that Series TC-802 Destaco clamps have a Holding Capacity (F_{HC}) of 200 lbs, well within our requirements. After downloading the free CAD file for the equivalent Series TC-202 manual clamps from www.ReidSupply.com, we find that $R_{HC} = 1.5$ inches (pivot point (P) to base front edge + 0.5 inches).

Plugging this information into Eq8:

$$F_S = F_{HC} R_{HC} / R_S$$

$$F_S = 200 \text{ lbs} \times 1.5 \text{ in} / 3.5 \text{ in} = 85.7 \text{ lbs}$$

As stated before, our application calls for a Holding Force (FH) of 105 lbs. Maximum length (RS) for Series TC-802 clamps is 2.31 inches and would need to be extended. The on-hand clamp can only provide 85.7 lbs force at the required contact point and does not meet our requirements. A better solution would be to look at a stronger clamp and repeat the analysis, e.g. Series TC-807 or 810 clamps.

The Toggle Clamp

As stated in Table 2, there are many advantages to using a clamp over a fastener. But there are many clamp types and styles to choose from. If you are considering replacing a fastener with a clamp, the most likely reasons are speed and eliminating the need for a tool. In most all cases, some style of toggle clamp is the best choice. More on toggle clamps is discussed later.

FIGURE 5: TOGGLE CLAMP OPERATION (IMAGE COURTESY OF DESTACO)

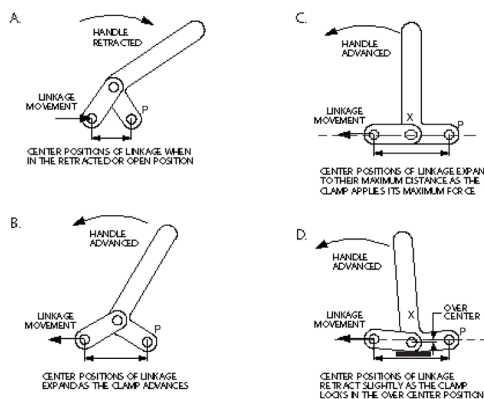

To understand how a toggle clamp works, refer to Figure 5. As you can see, there are four stages in the operation (A, B, C & D) of a toggle clamp and two components to the mechanism (handle and linkage). As can be seen in Figure 5, the handle pivots around a fixed point at "P" while the attached linkage follows. It should be noted that other components have been eliminated in Figure 5 to avoid confusion. Operation is as follows:

- A. The handle is in the pulled OPEN position, pulling one end of the linkage upward and the other toward the stationary pivot point at "P". At this point, the clamp is disengaged from the workpiece.
- B. The handle is advancing forward toward the closed position. The linkage is forced downward at one end, which moves the other farther away from the stationary pivot point "P". Note the component attached to the far end of the linkage would be moving forward at this point.
- C. At this point, all pivot points are aligned, the clamp is closed and applying its maximum Clamping Force (F_c) or Exerting Force (F_e). However, the clamp is unstable and vibration could easily move point "X" up or down, which would release the clamp.
- D. To stabilize the clamp, the handle is allowed to continue forward and move point "X" past the alignment point. At this point a small amount of F_e is sacrificed to maintain stability. The Opposing Force (F_o) would advance the handle forward and move point "X" downward. A stationary stop is added to prevent further action and lock the clamp in position. Maximum Holding Capacity (F_{HC}) is now determined by the strength of the components and the ability of the stop to resist FO through the clamp mechanism.

Once the toggle clamp is closed, the workpiece contact (spindle) position is constant and cannot be varied except by adjusting the attached spindle, if used. Some variance can be accomplished by using a rubber or spring-loaded spindle. Once optimum adjustments are set for the workholding system, it should not be changed.

Design Considerations

Information included in this Resource Guide extends beyond the catalog to provide details, tables, charts and other information to further assist engineering, maintenance and others in selecting the best part for design and application. Although considerations for every and all applications is beyond the scope of this manual, purchases are typically based on one or more of the following parameters.

Workholding Applications

Products available for industrial clamping and workholding come in a wide range of options, features and functions. Some products may be suitable for the do-it-yourselfer while others require some engineering skills and know-how. Whatever your application, with some imagination, creativity and artistry, a workholding system can be designed.



CLAMPS & WORKHOLDING

Some typical workholding systems include:

- Hold together - Clamping where two or more objects are held in position for assembly or building. This could be with a bar, "C", plier clamp or even a toggle clamp.
- Locate – Straight-line clamps or cam clamps can be used as mechanical stops while applying minimal Clamping Force to ensure the workpiece is properly aligned and held for assembly or welding.
- Hold-down - In a workholding system, most any single-ended clamp can be adapted as a hold-down clamp. Strap clamps are widely used to hold-down a workpiece on a T-slot table for machining. If no fixture is involved, double-ended clamps can be used to hold two or more workpieces together or simply clamp the workpiece to a work table or other surface.

Non-typical applications ("thinking outside the box") include:

- Actuator - Open/close lid or small door.
- Assembly - Push pin in place, insert ring over shaft or in assembly body.
- Most workholding applications fall into three groups: assembly, machining and test.

Assembly

For assembly applications, the previous discussion of workholding forces (FC) becomes less relevant. This is because, during most assembly applications, external forces applied to the workholding system are relatively small. Welding adds little or no forces to the workholding system. Manual operations, such as drilling, gluing, adding fasteners or placement of additional components adds more external forces than welding, but still very light compared to machining applications. Other than material weight, in most cases, position, not forces, is the most important consideration for assembly workholding.

Machining

Workholding systems for machining are typically more complex and require a higher Holding Force (F_H) than assembly applications. Drilling, boring, milling, sanding, facing or any other machining operations that introduce a tool to the workpiece adds external forces to the workholding system. The sum of these forces can be in thousands of pounds. The workholding system has to be designed with a Holding Force (F_H) high enough to secure the workpiece. Workholding devices such as Carver, strap, pneumatic and hydraulic clamps are needed for these high-stress machine operations.

Test

Unless you are doing stress tests, like most assembly applications, workholding systems for testing do not require high Clamping Forces (F_C). In many cases a CMM or manual measuring tools are used to extract dimensions. Environmental testing may also be applied, in which case, other considerations apply.



CLAMPS & WORKHOLDING

Physical Attributes

Many things are considered in the design of workholding systems. Physical attributes of both Clamps and Workholding devices and workpieces are primary. These attributes include, but are not limited to:

- applied forces
- space allotted
- material

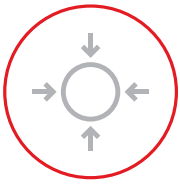

Applied Forces

Many of the topics discussed in "Clamping and Workholding Basics" relate to torque, vectors and applied forces in a workholding system. Although the applied forces can be calculated and analyzed in detail, the effects of these forces must also be considered relative to the system as a whole (e.g. workpiece, workholding system, external devices (e.g. tool) and the machine). Math and theory is only the beginning of engineering and designing a workholding system, getting us in the ball park (refer to section on "Machining Forces"). Most of the time, the entire process is tweaked with trial-and-error testing before actually going into production.

Heavy-duty industrial clamps serve two primary functions: First, they must hold the workpiece against its locators. Second, they must prevent workpiece movement. When designing a workholding system with single-ended clamps, the locators should provide the primary Opposing Force (F_o) to both the movable clamp and external forces from machining, assembly or testing.

Space Allotted

Space is an issue when it is too small, not environmentally friendly or not accessible. Human factors must also be considered relative to space available. If space is an issue for any reason, remote operation is usually the best solution.

Designing the workholding system should happen along with the machine and process. If machine and process are designed solely around the workpiece(s), there may not be enough room for workholding devices.

Material

Material properties are relative to the clamping point for both the workpiece and workholding device.

Relative material properties include:

- Contour - As stated earlier, a minimum of three points are required to hold position on any solid. It was also stated that the Clamping Force (FC) has greatest affect if applied normal to the workpiece. If the workpiece has a contoured or profile surface, each clamp must be mounted at a different angle to compensate.



CLAMPS & WORKHOLDING

- Hardness - If the contact point of the clamp is harder than the material or too much Clamping Force is applied, the workpiece damage can result. Friction is inversely proportional to hardness, as hardness increases, friction decreases laterally. This means that as friction increases, less Clamping Force is required to hold the workpiece laterally. It also implies that a hard workpiece can be held with less Clamping Force if the clamping point is softer. Hardness is a factor for calculating Machining Force.
- Surface - Surface area and roughness also contribute to the required Clamping Force. A rough surface is easier to hold down than a smooth one. Increasing the surface area of the clamp can also improve Holding Force, but also serves to increase the number of contact points and affects accuracy.
- Stiffness - This is not as much a property related to forces as it is to clamp/ locator location. The main concern here it with distortion and deflection due to workholding forces. A workholding system should be able to secure a thin or flexible material without changing its shape or thickness. A clamp can bend steel if the Exerting Force (FE) does not have an Opposing Force (FO) which is directly in line with it.
- Corrosive properties - In many cases, workholding systems are within metal cutting machines which require coolant to control temperatures. All components of these workholding systems must be compatible with the chemicals used.
- Temperature - Expansion and contraction of the workpiece and workholding system is a concern for high- and low-temperature applications, such as welding. Temperature can also change the workholding forces.



Clamp Position

FIGURE 6: SAMPLE CLAMP POSITIONS

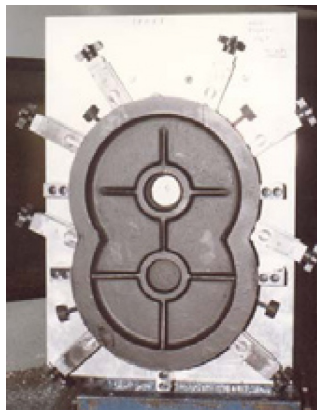

Clamp position, Figure 6, is the second most important consideration after Holding Force. In deciding where to position a clamp, consider the following criteria:

- Position the clamp opposite a locator or stop. The Exerting Force (F_E) of the clamp should be directly in line with the Opposing Force (F_O) of locator or stop. Refer to Figure 2 and Figure 3.

CLAMPS & WORKHOLDING

- Ensure locator or stop is aligned to absorb external forces, such as a tool. The clamp should only be used to secure the workpiece against the locator or stop and prevent movement in the workholding system.
- The clamp should be positioned at the most rigid points on the workpiece and workholding base. If movement can occur against the base, consider using a gripper or pad-style stop, as shown in Table 6.
- Avoid positioning the clamp at an angle (other than normal) to the workpiece surface. This will diminish the Exerting Force (F_e) of the clamp. Refer to Figure 2.
- Do not interfere with machining, assembly or testing.
- Do not interfere with workpiece loading and unloading.
- The clamp must clear any machine structure during indexing or table movement.
- If manual, the clamp must be reachable and operable by the operator. The operator can tire if the clamp operates at an odd angle or is difficult to operate. Refer to "Human Factors" for more details.



Remote Operation

Remote operation must be employed if the workpiece being held is not easily accessible. It could be

- in an enclosed space.
- too high or far away.
- in a toxic environment.

In any case, a remote workholding system is either pneumatic or hydraulic and is always faster than manual operation.

Cycle Time

For many production processes, reduction of cycle time and process improvement is a never-ending task of the process or manufacturing engineer. As implied in Table 2, in many cases, a quick-acting clamp is employed faster than a fastener. But, the operator still has to close each clamp manually in the workholding system. If several clamps are required, a pneumatic or hydraulic clamping system can simultaneously close all clamps and save even more cycle time, even if the system continues to be manually activated.

Maintenance

If hoses are used, they should be regularly inspected for leaks. Other than occasional cleaning and component replacement after being machined or otherwise damaged, workholding systems should need little maintenance.

Human Factors

Mil-Std-1472F [3] includes several references to human factors relative to applications designed for human operation. After several years of studies, this report includes design criteria for the Department of Defense. This single document is a primary resource for engineers and organizations such as the Human Factors and Ergonomics Society (HFES).



Some of the information included can be used as design criteria relative to Clamps and Workholding. It should be noted that human factor concepts and practices are still applicable to automated systems for human operation, accessibility, maintenance and repair.

Angle of Approach

Many factors determine the best angle of approach for Clamps and Workholding hardware. Whether the operator is sitting, standing, prone or in a confined space, some thought should be given to determine the best approach to access and operating the manual clamp or locator. For instance, different muscle groups are required when operating a clamp on the back, front, and left or right side of a workholding system. Also, body and elbow room may be limited in a confined space, such as in a CNC mill or turning center. Consider the style of handle, vertical, horizontal or T-handle, when specifying manual clamps.

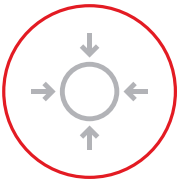

Applied Forces

Muscle strength depends on many factors including fitness of the individual, muscle cross-section area, the size and shape of the muscle, bone strength, etc. Maximum strength is limited by the cross-sectional area and condition of the bone relative to the muscle group required. Mil-Std-1472F [3] Figures 8, 11, 18, 23 and 42; plus Tables XVIII and XIX show various positions and lists human strength data for both men and women.

According to Human Engineering Mil-Std 1472F [3], Figure 23, the maximum human pull strength is a little over 200 pounds for males. It also states this cannot be sustained for a long period of time. Clamps are able to exert a much larger force against the workpiece and sustain it for long periods of time. In the design of workholding systems, considerations should not be based on maximum human strength, but rather minimum strength of the human body. This is especially true when either men or women must interact with your design. Mechanical principles should be employed that allow operators to easily manage the controls with minimum force or effort. For Destaco products [4], the mechanical advantage (MA) available ranges from 2:1 to 10:1.

Grip

Figure 42 of Mil-Std-1472F [3] lists recommended dimensions for a variety of handles based on bare, gloved or mittened hands. If positive grip is an issue, consider the style of handle, vertical, horizontal or T-handle, when specifying manual clamps.

Feedback

Feedback is the difference between an open-loop and closed-loop system. In an open-loop system, operation of the workholding device does not directly include feedback. However, being able to visually see or feel the workpiece move into position and clamp close is feedback, but it is external to the workholding system.



FIGURE 7: EXAMPLE POWER CLAMP WITH FEEDBACK



Position sensor and cable.

Feedback, Figure 7, is a vital part of an automated closed-loop system design where some measure of the object being controlled is provided to the processor and/or operator. If the workholding system being controlled is not visible or accessible, feedback is necessary to properly and accurately position and secure the workpiece. Also, in an automated system, feedback may be required to ensure clamping is complete before the program moves on to the next operation. If this is the case, consider adding a sensor or other means of providing this information.

Safety

Of course, safety is high priority for any application, especially when human interface is required. For example, Destaco toggle clamps are designed to minimize pinch points. Automated systems must provide protection and safety lockouts where motion is generated, e.g. pneumatic and hydraulic clamps. Below are some resources for safety information and compliance for both US and European directives.

ANSI - The American National Standards Institute establishes and provides standards for industry in the US. Many of these are safety related, especially where labels and signs are concerned relative to Clamps and Workholding Systems.

CE Mark - A Community Europe directive required for products to be sold in Europe. This directive requires OEM's to conduct, document and provide (as needed) Risk Analysis data for their product.

ISO - Like ANSI, the International Organization for Standardization provides recommended standards for the international community.

OSHA - The Occupational Safety & Health Administration is a branch of the U.S. Department of Labor. Much information relative to safe machine design can be obtained from this organization.

RoHS - Primarily European, this Restriction of Hazardous Substances directive is also a concern in the US.



CLAMPS & WORKHOLDING

Selecting the Correct Component

As mentioned in the section “The Art of Fixturing and Design”, selecting the best components for a workholding system or other application is important. However, your selection need not be limited to the Clamps and Workholding section of the ReidSupply catalog. For instance, an online search for “workholding” yields items in two of the twelve categories (listed in Resource Guides at the beginning of this manual), “locator” yields items in three categories, entering a search for “stops” yields six and “pads” or “clamps” yields items in nine categories. Part of the “art” in design is using any available product, part or component that works best for your application.

Selection Parameters

Knowing and understanding the previous information leads to the selection process based on:

- Workpiece
- Required Holding Force
- Type of clamp and/or workholding device(s)
- Cost

NOTE : For the purpose of this Resource Guide, only components in the Clamps and Workholding category of the Reid Supply catalog will be included. Workholding components, such as locators, can also be found in the Tooling Components category.

Workpiece

As previously implied, the entire workholding system is designed around the workpiece(s) that is to be secured during a machining, assembly or testing operation. In selecting workholding devices:

- If the workpiece material is not hard enough to deliver the required Opposing Force (FO), it may dent, bend, break or otherwise be damaged. In this case, consider decreasing Exerting Force (FE) for each clamp by:
 - taking advantage of friction by using a softer tip on the clamp spindle.
 - adding more clamps. If using single-ended clamps, be sure to add a stop to the opposing side to clamp against.
- If one workholding device does not have enough FE for the required Holding Force (FH), add more.
- If more than one clamp is used to hold down a workpiece, the total Exerting Force (ΣFE) is equal to the sum of all exerting forces on the workpiece in the same plane, X, Y or Z.

Required Holding Force (F_H)

The importance and amount of F_H required to secure a workpiece in a workholding system depends on the type of workholding system: machining, assembly or testing. As stated before, unless external forces are being applied or the weight of the workpiece is important, Holding Force (F_H) is not a primary concern for assembly and testing workholding systems.

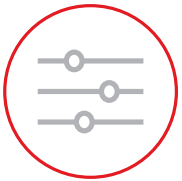

CLAMPS & WORKHOLDING

On the other hand, machining does provide external forces. The “Machining Forces” section of this manual includes the basic formulas for calculating required Holding Force for a machining application.

Many parameters are involved in determining the required holding forces of a workholding system. If calculated, the results are only a starting point for designing the workholding system which should be tested before being put into production. Once holding forces are understood and known, selecting workholding devices can happen based on the properties of the workpiece stated before and the distribution of the holding forces.

- If external forces are involved, consider purchasing devices strong enough to compensate for these dynamic changes in the workholding system. The workholding system should be designed to apply external forces opposite the Clamping Force and into the fixture body, locator or stop.
- If multiple workholding devices are required, such as on a circular lid, the devices should be the same and the required Holding Force divided equally among them. The devices should also be configured to apply the same Clamping Force and torque.

Workholding Type

Once workholding capacity is known, a major consideration for selecting a workholding device is type.

TABLE 3: TYPES OF WORKHOLDING DEVICES

Type	Pros	Cons
Manual	<ul style="list-style-type: none"> • Can be operated manually. • For screw types, variable pressure can be applied • Low cost. • Very high capacity for Carver and strap clamps. 	<ul style="list-style-type: none"> • Limited holding capacity for toggle clamps. • Must be accessible to operator. • No remote operation. • Can have pinch points during operation.
Pneumatic	<ul style="list-style-type: none"> • No handle required. • Can be operated remotely with less operator fatigue. • More than one clamp can be operated simultaneously or in programmed sequence. • Can have feedback sensors for open and closed positions. 	<ul style="list-style-type: none"> • Requires pneumatic pump, valves, controls, hoses and equipment. • Seals sensitive to high temperatures. • No manual override.
Hydraulic	<ul style="list-style-type: none"> • Higher capacity than pneumatic devices. • No handle required. • Can be operated remotely with less operator fatigue. • More than one clamp can be operated simultaneously or in programmed sequence. • Can have feedback sensors for open and closed positions. 	<ul style="list-style-type: none"> • Requires hydraulic pump, valves, controls, hoses and equipment. • No manual override.



Cost

The goal of Reid Supply and this document is to ensure the customer gets the best part for the intended application. Quality does not equate to purchasing the highest-cost item in its class. It equates to purchasing the best item that meets all the requirements for the applied application, at the best price. If a lesser product is used, future replacements, repairs or modifications may result in even higher costs.

Note that most clamps are made of metal. Metal can fatigue under prolonged stress and begin to bend or deform. Even in an assembly or testing workholding system where holding forces are not as important, workholding devices can wear out and need replacing if they are not strong enough to handle the applied stress.

Clamp Specifications

Several parameters are used to define a clamp. Although there are several styles of clamps, they all have a common purpose - workholding. As indicated in the previous sections on "Torque" and "Vectors", to hold a workpiece in position, forces must be applied at the correct magnitude, direction and locations. The primary specification for selecting a clamp is the holding capacity. Next, is the size, which includes opening distance (double-ended clamps) and reach (distance into the workpiece to the clamping point).

Holding Capacity is defined in more detail under the section on "Clamps" and the distinction between double-ended clamps and single-ended clamps. More details about size are also discussed in the sections on "Clamps". When specifying a single-ended clamp for your application, understanding the relationship between torque, the distance from the clamping point to clamp arm pivot point and the resulting Holding Force is important. This will help ensure the clamp selected has enough strength to meet application requirements.

Clamping Force for Strap Clamp

Although formulas are available for calculating Clamping Forces of a strap clamp, the primary limitation is in the tensile strength of the stud as shown in Figure 8. Table 4 lists the Clamping Force (F_c) for a typical manual strap clamp with various-size studs placed centered between the contact point on the workpiece and the clamp rest (2-to-1 clamping-force ratio).

FIGURE 8: SAMPLE STRAP CLAMP APPLICATION

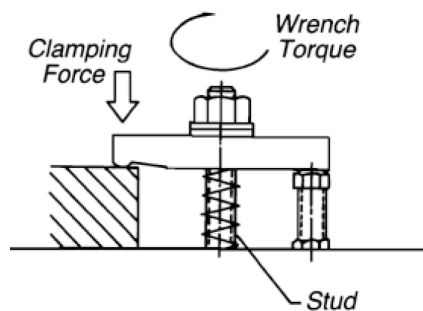

CLAMPS & WORKHOLDING

TABLE 4: THREADED STUD CLAMPING FORCES

Stud Size	Recommended Torque ² (ft.-lbs.)	Clamping Force ³ (lbs.)	Tensile Force In Stud ³ (lbs.)
#10-32	2	300	600
1/4-20	4	500	1000
5/16-18	9	900	1800
3/8-16	16	1300	2600
1/2-13	38	2300	4600
5/8-11	77	3700	7400
3/4-10	138	5500	11000
7/8-9	222	7600	15200
1-8	333	10000	20000

1) More detailed information can be found in the Machinery's Handbook listed in Table 15.

2) Clean, dry clamping stud torqued to approximately 33% of its 100,000 psi yield strength (2:1 lever ratio).

3) Values assume stud is positioned centered between workpiece and clamp rest as shown in Figure 8.

Maximum Holding Capacity

As stated in "Clamping and Workholding Basics", workholding devices always include a "Maximum Holding Capacity". It is important not to exceed this value when selecting a workholding device ($F_H < F_{HC}$). When selecting the proper workholding device, always include a safety factor allowing for external forces that may cause the measured or calculated Holding Force (FH) to be exceeded. Also keep in mind the difference between Clamping Force (F_C), Exerting Force (F_E) and Holding Force (F_H).

Size

Physical size can be important because:

- it is directly proportional to the Maximum Holding Capacity
- space constraints may be limited

If size is a limiting factor, multiple devices may be the solution.

Modifications

Modifications to the workholding device may be required. If modifications are made, they can affect the relative forces exerted. Refer to the sections on "Workholding" and "Clamps" for required calculations and details. If uncertain on how a modification will affect your workholding system, contact Reid Customer Service at the number below or email at sales@reidsupply.com and put "Customer Service" in the subject line.

Power Workholding Devices

Power workholding devices are operated by either pneumatic or hydraulic systems. The above specifications still apply for clamp mechanism specifications. There are two basic types of pneumatic and hydraulic cylinders: single-action and double-action. Some specifications for each are listed in Table 5.



CLAMPS & WORKHOLDING

TABLE 5: SINGLE-ACTION VS. DOUBLE-ACTION PNEUMATIC AND HYDRAULIC CYLINDERS

Specification	Single-Action	Double-Action
Unclamp	Spring	Pressure
Clamp	Pressure	Pressure
# Ports ¹	1	2
Hoses ²	One Set	Two Sets
Swing	Optional	Optional
Push	No	Yes
Pull	Yes	Yes

1) A single-action may include a second port to exhaust air during clamping.

2) A second hole may be required for the exhaust port of a single-action cylinder. This is done to prevent coolant or other contaminants from entering the cylinder.

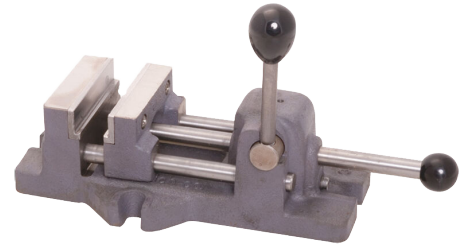

Workholding Devices

Selecting the proper device for the workholding system is an important step in designing a well-functioning fixture.







Table 6 - Workholding devices and their pros and cons.

Table 7 - Workholding attributes and their pros and cons.





CLAMPS & WORKHOLDING

TABLE 6: WORKHOLDING DEVICES

Style	Pros	Cons
 <p>Clamping Systems</p>	<p>These clamping devices consist of multiple components which work together to apply holding forces. Clamping action is typically accomplished through the non-concentric design.</p> <ul style="list-style-type: none"> • Holding Capacities up to 19,000 lbs can be obtained. • Low profile. • Easy to use. • Some can provide a Clamping Force in two directions, outward and downward. • Machinable version can be used for oddshapes. 	<ul style="list-style-type: none"> • Tool required. • May require a custom designed base.
 <p>Grippers</p>	<p>Grippers are serrated stops used to grip and hold the workpiece in position while machining or assembly. They can be used as a stand-alone component or opposite a clamp. With matching threads, can also be used as a spindle for hold-down or straight-line clamps.</p> <ul style="list-style-type: none"> • The serrated surface is used to grip and increase clamping area. • Easy to install or replace. • With swivel, adjusts to non parallel surface. • Maintenance free. 	<ul style="list-style-type: none"> • May require some machining: drill & tap or brazing. Gluing is not recommended. • Tools required.
 <p>Rest Pads</p>	<p>Like grippers, rest pads are used to support the workpiece as stand-alone or opposite a clamp. With matching threads, can be used as a spindle for hold-down or straight-line clamps.</p> <ul style="list-style-type: none"> • The smooth surface increases clamping area. • Available in a variety of materials to match workpiece surface requirements. • Easy to install or replace. • With swivel, adjusts to non parallel surface. • Can be mounted at any angle. 	<ul style="list-style-type: none"> • Require some machining: drill & tap or weld. • Tools required.
 <p>Screw Clamp</p>	<p>Any clamp consisting of a thread shaft and a means to grip and rotate the end of the shaft to and from the workpiece surface. The Holding Capacity depends on the shaft diameter and thread size.</p> <ul style="list-style-type: none"> • Simple and versatile. • Requires very little space to operate. • Can be used with a variety of pads or grips. • Clamping time can be decreased using quick-acting inserts. 	<ul style="list-style-type: none"> • Pad purchased separately. • Clamping time can be relatively long if the clamp needs to be moved several inches.
 <p>Spring Clamps</p>	<p>Clamps that use a spring to create the Holding Force (F_H).</p> <ul style="list-style-type: none"> • Quick to apply. • Can be adjustable. • Excellent for many assembly and gluing applications. 	<ul style="list-style-type: none"> • Depending on strength of clamp and operator, continuous use can cause fatigue. • Generally very low Holding Force (F_H), 1 - 50 lbs. • Limited opening size.
 <p>Strap Clamp</p>	<p>An elongated bar acting as a lever to secure the workpiece into position. A center hole or slot allows the clamping screw to pass and create a fulcrum for applying an Exerting Force (F_E) on the workpiece. See Figure 8.</p> <ul style="list-style-type: none"> • Can have very high Holding Compacity (F_{HC}). • Simple and versatile. • Works well on a T-table. 	<ul style="list-style-type: none"> • Clamping force limited by stud size. • Requires additional clamp rest. • Tools may be required.
 <p>Straight-Line Action Clamp</p>	<p>Usually used to clamp from the side, these workholding devices come in many styles and configurations.</p> <ul style="list-style-type: none"> • Can be used in applications with wide size variance or for long opening and closing motion. • Infinite adjustable stroke and clamp positions allow variance in workpiece shape. • Fast action for clamp and release. • Can be used as a stop. 	<ul style="list-style-type: none"> • Can lose tension under vibration. • May corrode if exposed to some chemicals. Do not submerge. • Abrasive dust can effect performance.

CLAMPS & WORKHOLDING

 <p>Swing Clamp</p>	<p>A clamp which swings into place for clamping and to one side for workpiece removal.</p>	
 <p>Vise</p>	<ul style="list-style-type: none"> • Easily swing out-of-the way for loading and unloading of workpiece. • Adjustable Clamping Force (FC). • Manual or remote with power options available. 	<ul style="list-style-type: none"> • May require tools.
 <p>Vise</p>	<ul style="list-style-type: none"> • Can have fixed or interchangeable jaws. • Firmly grip materials from hardened steel to soft plastic and from square to round shapes. 	<ul style="list-style-type: none"> • Most must be mounted to workbench or other secure surface for heavy workpieces and secure operation. • Works best if opposing workpiece faces are parallel.







Workholding Attributes

Table 7 lists some basic attributes relative to workholding devices with pros and cons for each.

If you do not find a desired attribute or adaptation, try using our online catalog or contact Reid Supply at the toll-free number listed below.

TABLE 7: WORKHOLDING ATTRIBUTES

Attribute	Pros	Cons
 <p>Cam Action Clamp</p>	<p>A clamp that is closed or actuated by a cam mechanism.</p>	
 <p>Clamp Rest</p>	<p>Used opposite of strap clamp for leverage.</p> <ul style="list-style-type: none"> • Adjustable. • Can be easily mounted in a T-table with T-nuts. 	<ul style="list-style-type: none"> • Can loosen with vibration if not fully engaged. • Tool may be required. • May require a custom designed base.
 <p>Clamping Pads</p>	<p>These are pads which fit on the end of screw clamps and are used to change the surface area of the clamp.</p>	
 <p>Step Blocks</p>	<p>Used as adjustable clamp rest for strap clamps.</p> <ul style="list-style-type: none"> • Easily replaces clamp rest. • Can be adjusted quickly and easily. • No tools required. • Can be steel or aluminum. 	<ul style="list-style-type: none"> • Can get separated from workholding system and misplaced.
 <p>Vise Jaws</p>	<p>Replaceable jaws designed to fit most vises.</p>	
	<ul style="list-style-type: none"> • Style can be changed to suit workpiece properties. • Vise is renewed by replacing jaws. 	



Toggle Clamps

Toggle clamps are the ideal choice for many quick-acting clamping applications. Selection can be based on Maximum Holding Capacity, size, shape and ergonomics.

Table 8 - Toggle clamp pros and cons.

Table 9 - Toggle clamp styles and their pros and cons.

Table 7 - Toggle clamp attributes and their pros and cons.







Except for plier clamps, toggle clamps are single-ended and require backing for the opposing side in the form of a gripper, rest pad, locator or fixture surface. Once set, toggle clamps demand consistency in operation and applied forces. However, some variance can be accomplished by using a hook or stop. See Table 10.

CLAMPS & WORKHOLDING

TABLE 8: TOGGLE CLAMP PROS & CONS

Pros	Cons
<ul style="list-style-type: none"> • Quick activation and release. • Once adjustments are set, demands consistency. • Some variance can be obtained by adding spring loaded spindle, latch or stop. • Holding force can be added by adding more clamps. • Pinch-point protection on newer models. • Multiple clamps can be used to achieve the desired Holding Force. • Toggle Lock-plus option resists vibration. 	<ul style="list-style-type: none"> • No variance in position without manual adjustments. However, spring loaded spindle can be used. • Clamping point must be within 0.5 mm (0.016 in).

TABLE 9: TOGGLE CLAMP STYLES

Style	Pros	Cons
 <p>Hold Down Clamp</p>	<p>Clamps used to hold-down the workpiece, fixture or other object. In many cases, the same components of the toggle clamp are used for pneumatic power workholding applications. Hydraulic toggle clamps require stronger components.</p> <ul style="list-style-type: none"> • Force exerted downward along bar. • Easily modified to adapt to workholding requirements. • Several types available, See Table 10. 	<ul style="list-style-type: none"> • Must calculate the Holding Force applied at spindle contact point based on distance from clamp arm pivot point. • Spring loaded spindle required to add variance in contact position.
 <p>Straight Line Clamp</p>	<p>As a single ended clamp, straight-line clamps apply pressure to one side of the workpiece. Holding force is not pro-rated for a longer plunger.</p> <ul style="list-style-type: none"> • Locks in extended (push) or retracted (pull) position. • Can be used as clamp, locator or stop. • Force exerted in-line with plunger. • Works well for side clamping. • Plunger can be extended without affecting Clamping Force or Holding Force. 	<ul style="list-style-type: none"> • Handle must travel 180° to lock in either position. • Depending on required forces, should not be used to push. • Spring loaded spindle required to add variance in contact position.
 <p>Latch Clamp</p>	<p>A latch clamp is used to pull and hold two pieces together. It works the opposite of a typical double ended clamp because it pulls, rather than pushes, two pieces together.</p> <ul style="list-style-type: none"> • Hook can be custom made (Contact Reid Supply Customer Service). • Pulling action well suited for many applications. • Can be horizontal or vertical. 	<ul style="list-style-type: none"> • Opposing connection, latch plate, may need to be manufactured. • Spring loaded hook required to add variance in contact position.
 <p>Plier Clamp</p>	<p>The plier clamp functions like a "C" clamp by compressing the workpiece(s). Several styles and configurations available.</p> <ul style="list-style-type: none"> • Hand held with pre-set jaws. • Various jaw widths and depths available with adjusted size. • Pull down version available. 	

CLAMPS & WORKHOLDING







Toggle Clamp Attributes







This section lists some basic attributes relative to toggle clamps. As stated earlier, a wide variety of styles are available as shown in Table 10.

NOTE: If you do not find a desired attribute of adaptation, try using our online catalog or contact Reid Supply at the toll-free number listed below.



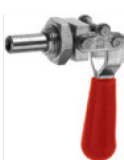
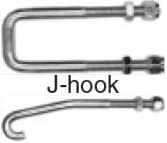

TABLE 10: TOGGLE CLAMP ATTRIBUTES

Attribute	Pros	Cons
<p>Various handle configurations are available for toggle clamps. It should be noted that each requires a different muscle group in the hands and arms to operate. Refer to "Human Factors" for more information. For each model, the degrees of handle and clamp bar movement is included in the catalog. Select the best configuration for your application.</p>		
 Vertical Handle	<ul style="list-style-type: none"> • Long handle is easy to grasp and pull downward. • Strong design. • Can be operated from most any angle. 	<ul style="list-style-type: none"> • Depending on workholding system and machine design, handle can get in the way of moving machine parts. Programming must avoid handle.
 Horizontal Handle	<ul style="list-style-type: none"> • Low profile. • Easily controlled with only thumb and forefinger. 	<ul style="list-style-type: none"> • Occupies more horizontal space on table or fixture.
 Pull-Down Handle	<ul style="list-style-type: none"> • Compact profile. • Handle moves completely out of the way. • Great for rotary table applications. 	
 T-Handle	<ul style="list-style-type: none"> • Tight profile. • Great for low or narrow space requirements. • Can be operated from either side. 	<ul style="list-style-type: none"> • Due to lack of torque in handle, maybe harder to close. • Can be harder to operate from side.
<p>Four different mounting options are available. Select the one that is best for your workholding system.</p>		
 Flanged Base	<ul style="list-style-type: none"> • Easily mounts on flat surface. • Can be mounted at any angle. 	

CLAMPS & WORKHOLDING

Attribute	Pros	Cons
 <p>Front Mount</p>	<ul style="list-style-type: none"> Clamping force is 90° to base. Great for vertical mounting applications. Well suited for cover hold-down applications 	
 <p>Straight Base</p>	<ul style="list-style-type: none"> Easily mounted on edge. Small footprint. 	
 <p>Thru-hole Mount</p>	<ul style="list-style-type: none"> Fast and easy mounting for straight-line clamps. Well suited for side clamp applications. Includes lock nut. Mounting plates available. 	<ul style="list-style-type: none"> Handle moves 180° from fully open to fully closed position.
 <p>Toggle Lock Plus</p>	<p>This style includes a locking mechanism which must be released to open the clamp.</p> <ul style="list-style-type: none"> Resists accidental opening of clamp due to vibration or when inverted. 	<ul style="list-style-type: none"> Can add to time required to open and close clamp.
<p>Three clamp bar configurations are available for hold-down clamps. Clamp bar degrees of movement is included in catalog for each model. Holding Force (FH) should be recalculated if distance from pivot point is changed.</p>		
 <p>U-Bar</p>	<ul style="list-style-type: none"> Allows for easy attachment of a spindle or an extension. Spindle position is adjustable vertically and horizontally. Can be either closed or open at the end; both designs function the same. Flange washers are provided and custom spindles can be purchased separately. 	<ul style="list-style-type: none"> Spindle position may shift over time.
 <p>Solid Bar</p>	<ul style="list-style-type: none"> Differs from U-bar only in design or shape. Can be cut to length or extended. Comes with bolt retainer for spindle. Once set, spindle can be adjusted vertically. 	<ul style="list-style-type: none"> Bar must be cut to length and bolt retainer welded on end. No horizontal adjustment of spindle.
 <p>Heavy Duty</p>	<ul style="list-style-type: none"> Same considerations as other toggle clamps, but stronger with larger holding capacity. Wider bar allows hole to be drilled for spindle. Bar can be cut to length and modified as needed. 	<ul style="list-style-type: none"> Larger size. Bar must be modified to fit application requirements. No horizontal adjustment of spindle.

CLAMPS & WORKHOLDING

Attribute	Pros	Cons
 <p>Cam Action Clamp</p>	<p>Similar to standard toggle clamp, but cam action allows for more variance.</p> <ul style="list-style-type: none"> • Variable handle position to allow variance. • Depending on style, workpiece height variance can be as much as 1/2 inch. 	<ul style="list-style-type: none"> • Can loosen if low Clamping Force during vibration. • Clamping point not consistent.
 <p>Spindle</p>	<p>The application of a spindle allows for adjustments to be made to the clamping point and exerting force.</p> <ul style="list-style-type: none"> • Allows up and down (hold-down) or in and out (straight-line) adjustment of the clamping point. • Various caps can be selected depending on workpiece material properties. • Swivel foot option is available. 	<ul style="list-style-type: none"> • Can be easily misplaced over time. • Requires tools to adjust. • For hold-down clamps, Holding Force (F_H) should be recalculated if distance from pivot point is changed.
 <p>Spindle Caps</p>	<p>A variety of spindle caps are available by shape and material. Shape affects contact surface area and coefficient of friction. Material can either compress onto the workpiece for more holding power or protect it from marring. It can also affect coefficient of friction.</p> <ul style="list-style-type: none"> • Change effect of contact point on material surface. • Easily installed or replaced. 	<ul style="list-style-type: none"> • May need periodic replacement.
 <p>Latches</p>	<ul style="list-style-type: none"> • Adjustable length. • Can add spring for size variances. 	<ul style="list-style-type: none"> • Must be compatible with clamp model. • If catalog choices are not compatible with application, custom manufactured hooks are available. Contact Customer Service at toll-free number on bottom of page .
 <p>Latch Plates</p>	<ul style="list-style-type: none"> • Several options to choose from. • Solid steel or stamped versions available. 	<ul style="list-style-type: none"> • Must be compatible with hook material diameter.



Power Workholding

Power workholding requires using pneumatic or hydraulic cylinders to open and close clamps

Table 11 - Power workholding pros and cons.

Table 12 & 13- Power workholding devices and their pros and cons.

Table 14 - Power workholding attributes and their pros and cons.

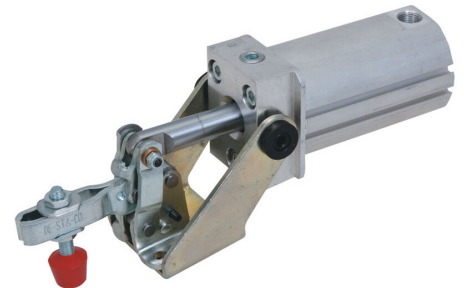
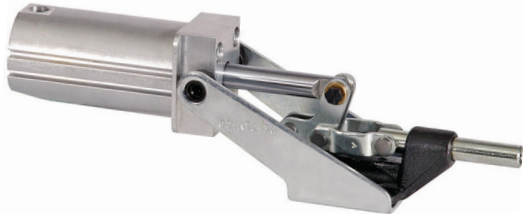

For more details, refer to Power Workholding Devices.

CLAMPS & WORKHOLDING

TABLE 11: POWER WORKHOLDING PROS AND CONS





Pros	Cons
<ul style="list-style-type: none"> • Remote operation. • Consistent force which can be adjusted by changing pressure. • Fast operation. • Simultaneous or sequenced operation of multiple clamps. • Most cylinders include piston magnet and grooves for sensors. • Ergonomically friendly. • Safe 	<ul style="list-style-type: none"> • Needs air or hydraulic fluid supply. • Requires hoses, valves and other components. • Cylinder seals and sensors are sensitive to high temperatures.

Pneumatic Clamps

The pros and cons of Table 11 applies to these clamps. They range from the basic clamp, which is an automated manual clamp, to strong, fast heavy-duty styles. Attributes and accessories are listed in Table 14.

Pneumatic clamps list an outer and inner Exerting Force at 80 psi. Outer refers to a point at the end of the clamp bar and inner refers to a point on the clamp bar closest to the clamp base. For example, for TC-8101 the values are shown as 275/500 (Outer/Inner). It also has a holding capacity of 700 lbs.

TABLE 12: POWER WORKHOLDING DEVICES

Style	Pros	Cons
 <p>Heavy Duty Clamp</p>	<p>Heavy duty clamps are built for strength. They have a higher holding capacity than lighter duty clamps without sacrificing speed.</p> <ul style="list-style-type: none"> • High holding forces. • Toggle lock remains if air is lost. • Sensor ready. • Roller and cam action. • Arm can be machined and/or modified. • Works well for high cycle rates. 	<ul style="list-style-type: none"> • Large size. • Some rework required to adapt clamp arm to application. • Single ended torque and Holding Force calculations apply.
 <p>Hold-Down Clamp</p>	<p>These basic pneumatic clamps are simply manual clamps with a pneumatic cylinder in place of the handle. Even the part numbers in the Reid Supply catalog are similar. For instance: a TC-202 manual toggle clamp has a Maximum Holding Capacity of 200 lbs, as does TC-802-U, the pneumatic version</p> <ul style="list-style-type: none"> • See Table 11. • Easily replaces the equivalent manual clamp. 	<ul style="list-style-type: none"> • See Table 11 • Single ended torque and Holding Force calculations apply.
 <p>Retractor Clamp</p>	<p>For this type of clamp, the arm retracts fully when closed, plus it extends and pivots down to firmly hold the workpiece when open.</p> <ul style="list-style-type: none"> • Low profile. • Small size. • Single acting. • Variable Clamping Force. • Accepts part variation. 	<ul style="list-style-type: none"> • Single ended torque and Holding Force calculations apply.
 <p>Straight-Line Clamp</p>	<p>As with the hold-down clamps, these basic pneumatic clamps are simply manual clamps with a pneumatic cylinder in the place of the handle.</p> <ul style="list-style-type: none"> • See Table 11 • Easily replaces the equivalent manual clamp. 	<ul style="list-style-type: none"> • See Table 11

CLAMPS & WORKHOLDING



Pneumatic and Hydraulic Clamps

Some styles are common among pneumatic and hydraulic clamps. Although hydraulic clamps are generally stronger than pneumatic clamps, they each have their place in workholding.

Pros and cons relative to pneumatic and hydraulic common clamps are listed in Table 13, below. Attributes and accessories are listed in Table 14 for both. More information can be found in the section "Power Workholding Devices" and on the Destaco and ENERPAC web sites.

NOTE: Custom modifications and product offerings beyond the catalog are available by contacting Customer Service at the toll-free number listed at the bottom of the page.

TABLE 13: POWER WORKHOLDING DEVICES

Style	Pros	Cons
 Swing Clamp	With a replaceable clamp bar, these pneumatic or hydraulic clamps swing left or right when opening and closing for easy insertion and removal of the workpiece. <ul style="list-style-type: none"> • See Table 11. • Available with pneumatic or hydraulic cylinders. • Arms rotate 90°, then down. • Quick swing and clamp movement. • Can be right or left hand swing. • Allows for variation in workpiece thickness. • Multiple mounting and arm options. 	<ul style="list-style-type: none"> • See Table 11. • Single ended torque and Holding Force calculations apply.
 Work Supports	Similar to straight-line clamps, work supports can be positioned to press and hold any workpiece in position. <ul style="list-style-type: none"> • Spring loaded plunger keeps contact with workpiece. • Size variance allowed. • Adjustable pressure and Exerting Force. 	<ul style="list-style-type: none"> • See Table 11.
 Hallow Cylinder	With hallowed through hole center, any rod can be actuated to move the stroke length of the cylinder. <ul style="list-style-type: none"> • Can push or pull. • Can actuate a rod of any shape or length. 	









Pneumatic/Hydraulic Clamp Attributes

This section lists some basic attributes relative to pneumatic clamping systems listed in Table 12. It includes accessories and variations to the pneumatic cylinders and clamp design.





If you do not find a desired attribute of adaptation, try using our online catalog or contact Reid Supply Customer Service at the toll-free number listed below.

CLAMPS & WORKHOLDING

TABLE 14: POWER WORKHOLDING ATTRIBUTES

Attribute	Pros	Cons
 <p>Accessories</p>	<p>As stated in Table 11, hoses, valves and other components are necessary to complete a pneumatic clamping system. Reid Supply offers all components needed to complete a pneumatic or hydraulic clamping system.</p> <ul style="list-style-type: none"> Includes all things needed to complete a pneumatic clamping system. More options can be found in the Pneumatic and Hydraulic section of the Reid Supply catalog. 	<ul style="list-style-type: none"> Some assembly required.
 <p>Enclosed Clamps in Table 12</p>	<ul style="list-style-type: none"> Fully enclosed for less maintenance in a harsh environment. Heavy duty design. Can have right, left or dual arm. Arm can be replaced or modified to suit. Works well in welding environment. Sensor ready. 	<ul style="list-style-type: none"> Large size. Some rework required to adapt clamp arm to application.
 <p>Swing Arms</p>	<ul style="list-style-type: none"> Wide variety available in single or "T" design. Pre-drilled for spindle insert. Can be modified as needed. 	<ul style="list-style-type: none"> Single ended torque and Holding Force calculations apply. Longer arms can generate friction at back side of cylinder rod during clamping.
 <p>T-Arm</p>	<ul style="list-style-type: none"> Can clamp two points at the same time. The Holding Force at each end is equal and 1/2 rod force. Pre-drilled for spindle insert. Fits most any hold-down cylinder. 	<ul style="list-style-type: none"> Some rework may be required. Single ended torque and Holding Force calculations apply for each side.
<p>A variety of cylinder bodies are available for swing and workholding clamps.</p>		
 <p>Block Style</p>	<ul style="list-style-type: none"> Basic square or rectangular shape. Can be mounted on any side or bottom. 	
 <p>Flange Mount</p>	<ul style="list-style-type: none"> Can be top, center or bottom mount. Usually includes threaded body. 	
 <p>Threaded Body</p>	<ul style="list-style-type: none"> Easily mounted. Adjustable body/clamping height. 	<ul style="list-style-type: none"> Jam nut, mounting bracket or custom mounting required.
<p>The amount of hydraulic fluid required to support a hydraulic system is determined by the accumulated total capacity of all cylinders, hoses and fixtures in the system. Fluid moves to and from the reservoir as needed during clamping and unclamping. The reservoir must meet or exceed this requirement. Two options are available.</p>		

CLAMPS & WORKHOLDING

Attribute	Pros	Cons
 <p>Air/Hydraulic Booster</p>	<ul style="list-style-type: none"> Converts shop air to high pressure hydraulic power. Eliminates need for pump where only singleacting clamps are needed. Multiple capacities available. 	<ul style="list-style-type: none"> Limited to small workholding applications.
 <p>Turbo Air/Hydraulic Pump</p>	<ul style="list-style-type: none"> Like the above booster, shop air is converted to high pressure hydraulic power. Can be used where input air pressure is limited. Can attain higher pressure than boosters. Can manage more clamps than booster. Can be mounted horizontal or vertical. 	<ul style="list-style-type: none"> Oil capacity is less for vertical mounting.
 <p>Rest Buttons or Pads</p>	<p>These can be used as a spindle on a clamp arm or on the end of straight-line clamps or some workholding cylinders.</p> <ul style="list-style-type: none"> Compatible with hold-down and straight-line clamps. Various shapes available to match workpiece shape and surface requirements. 	
 <p>Sensors</p>	<p>For some remote applications, the use of feedback devices is necessary to ensure correct operation of the clamp or workholding cylinder. For PLC or other logic applications, this feedback may be necessary before continuing operation.</p> <ul style="list-style-type: none"> Provides positive feedback for open or closed positions. Two sensors can be used to verify both opened and closed states. Many cylinders are designed to accept sensors. If not, other sensors can be aligned with components of the workholding system to provide feedback. 	<ul style="list-style-type: none"> Not universal, ensure the sensor to be attached matches the cylinder design. Some cylinders do not have magnetic inserts on the cylinder plunger and are not compatible with sensors. In some cases, magnets can be added.

Custom Products

Can't find what you need? Contact our Customer Service department using the toll-free number listed at the bottom of the page. Reid Supply offers special ordering, rework and machining services to customize components needed for workholding applications.

Summary

As stated before, fixturing is an art, but the experienced designer's primary advantage is knowledge; understanding the required engineering and what tools, hardware and services are available. Technology is always changing, which leads to new choices for "thinking outside the box".



The primary goal of this document is to help select the best part for your application needs. If you need more information, would like to add information or comment on the contents, contact the Customer Service department using the toll-free number listed at the bottom of the page. Or Email us at sales@reidsupply.com (enter "Resource Guide" or "Technical Assistance" in the subject line).



CLAMPS & WORKHOLDING

Glossary

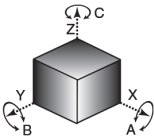
Below is a list of terms used in this document.

Term	Definition
Σ	Mathematical summation symbol implying the addition of all values and variables in the function. $\Sigma F = F_1 + F_2 + F_3 + F_4 + \dots + F_n$
Axial	A direction parallel to and along a given axis.
Cartesian Coordinate System	A mathematical system used to define points in a two or three dimensional planes X and Y or X, Y and Z respectively. For more details and application, refer to Vector and Degrees of Freedom.
Clamp Arm	See Clamp Bar.
Clamp Bar	The component of a single ended clamping device which directly or indirectly clamps down on the workpiece. Torque for F_c , F_e , F_h and F_{hc} are all referenced from the pivot point of this component.
Clamping Force (F_c)	The amount of force or pressure applied to the workpiece(s) by the clamp. Also see Exerting Force (F_e).
Clamping Point	The point (P_c) where the clamping device comes in contact with the workpiece.
Datum	A point, line, surface or feature considered to be theoretically exact that is used to locate the part or the geometric characteristic features of the part.
Degrees of Freedom	The number of possible directions a workpiece can move normal to the surface minus any fixed sides.
	
End-Affector	The business end of a robotic arm. It is a type of fixture or gripping mechanism designed to hold a specific tool or part. In some cases, it can be changed like the tool changer on a CNC machine. It can also be designed as a programmable gripper to adapt to more than one tool or part.
Exerting Force (F_e)	Amount of force (FE) exerted by the clamp normal to the surface of the workpiece. The workpiece(s) applies an Opposing Force (FO) against FE. Typically $FO = FE$; if FE or $FH > FHC$, the integrity of the workholding device is compromised. If the applied force is not normal to the workpiece surface, FE is a component of the applied force that is normal. See Vector.
	
Fixture	A workholding system used to hold a workpiece(s) securely in position while machining, assembly or testing.
Hold-down Bar	Another word for Clamp Bar as referenced to single ended clamping devices.
Holding Capacity (F_{hc})	The maximum rated Holding Force (F_h), at the clamping point, for clamping or workholding products. It is based on the material and mechanical design of the workholding device.
Holding Force (F_h)	The amount of force applied to a workpiece by a clamp or workholding device at the contact point. (Also see Holding Capacity, Exerting Force and Opposing Force.)
Jig	A device which guides the tool along a path. In some cases, it may also hold the tool. Mostly used in manual machining operations.
Locating Point	The point where the locating device comes in contact with the workpiece.
Manual Force (F_m)	The force required to close or activate the clamp.

CLAMPS & WORKHOLDING

Term

Definition

Mechanical Advantage (MA)

The number of times a machine multiplies the force applied to the input compared to the force exerted at the output. For instance: many toggle clamps have a MA of 2:1. This means that if 50 lbs of force is applied to the handle, the clamp bar can exert as much as 100 lbs of force at the contact point on the workpiece.

Normal

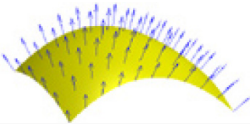

In reference to vectors, refers to a vector that is perpendicular to a surface at the clamping point. If the surface is curved, as shown to the left, normal refers to a vector along the line drawn from the center of the curve at and through the clamping point.

Off-set load



Used to define the condition where two or more applied forces are opposing but not along a common center.

Opposing Force (F_o)

Amount of force (F_o) exerted by the workpiece against the Exerting Force (F_e) of the workholding device.

Polar Coordinate System

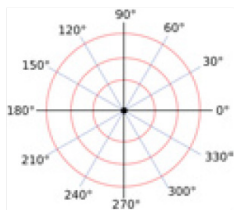

A two dimensional coordinate system consisting of points in the system defined by angle and distance from a common center. A 3D version would include a height (Z axis). A vector in this system would have a one component for 2D system and two components (direction outward or inward in Z axis) for 3D system. This coordinate system is used for turning operations for machining, assembly or testing. An example would be the body of a rocket engine. Can also be used in defining and calculating torque.

Side-Loading

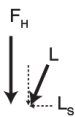

Occurs when the direction of the applied load (L), usually from a tool, has a vector component (L_s) not perpendicular to the Holding Force (F_H). If LS has enough magnitude, it can shift the workpiece during machining.

Spindle

In clamping, refers to the changeable shaft and pad which comes in contact with the workpiece. The shaft is usually threaded.

Torque

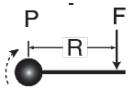

Measured in Nm (Newton-meters) or ft-lbs (foot-pounds), Torque is the resulting radial force (F) applied over a radial distance (R) at, and normal to, the pivot point (P). The equation: $T = FR$
For example: if a force (F) of 10 lbs is applied 2 feet (R) from the center of the pivot point (P), the resulting torque would be 20 ft-lbs; or: 2 ft x 10 lbs = 20 ft-lbs.

Vector (V)

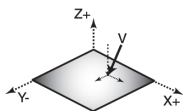

Having a magnitude and direction, a vector (V) represents a physical property; for the purposes of this document, force. The magnitude can be measured in units of pounds, velocity, acceleration, etc.. Direction is typically shown in a cartesian coordinate system, as shown on the left. For the purpose of analyses and mathematical calculations, a vector is broken down into vector components along the X, Y and Z axes where they can be added when more than one vector is relative.

Working Plane

The plane of a workpiece or workholding system where machining, assembly or testing is being performed. Does not have to be parallel to the coordinate system of the work table or fixture.

Workpiece

The part(s) or object(s) being held in place during workholding.

CLAMPS & WORKHOLDING

References

The following is a list of references used in to create this document. They are referred to by number, i.e. [5], in the text where applicable.

1. www.matweb.com
 2. Human Factors and Ergonomics Society (www.hfes.org)
 3. Human Engineering - mil-std-1472f
Department of Defense Design Criteria Standard, August 1999.
 4. www.Destaco.com
 5. www.ENERPAC.com
 6. www.Fairlaneproducts.com
 7. Dennis R Andrews PhD, PSP, CECD: "Concepts in Human Factors Engineering (3): The Energy Force of Our Frame," Expert Article Library (http://expertpages.com/news/concepts_in_human_factors_engineering_3.htm) 2006.
 8. Prakash Hiralal Joshi: "Jigs and Fixtures Design Manual" Second Edition 2003 McGraw-Hill Professional
 9. Edward G. Hoffman: "Jig and Fixture Design" Fifth Edition 2004
 10. Erik Karl Henriksen: "Jig and Fixture Design Manual" 1973 Industrial Press Inc.
-

Notes

CLAMPS & WORKHOLDING

Notes



**Check Out Clamps &
Workholding Catalog**

This Resource Guide is for reference only. The information provided is intended to assist in the selection of products sold by Reid Supply and its vendors. As Reid Supply and its vendors are not typically aware of or possess any expertise in the systems or processes for which products are being applied, we cannot accept any responsibility or liability for the outcome thereof.

Furthermore, with new and old technologies continually evolving and changing, it is impossible to address all systems, processes and applications for which Reid Supply products are purchased. Reid Supply also has little control over materials and processes from which our products are produced.

In addition, due to the nature of some materials; colors, textures, shapes and sizes may lack consistency.